

ScopeDome
sky observatory



The assembly instructions

for ScopeDome 3M ver 3.0 dome

Hereby user guide describes, step by step, all the operations to be accomplished for ScopeDome proper assembling. The manufacturer recommends to set-up the dome according to the procedure hereby referred. Mounting the dome in recommended sequence ensures efficient dome's operation and - at the same time - allows avoiding unnecessary steps and waste of time when fitting-up the dome.



How to order and calculate the price of ScopeDome dome

ScopeDome dome ver. 3.0 can be ordered in two basic options:

- with no side door panel,
- with side door panel.

There are all the drives available for every dome:

- rotary drive,
- shutter drive.

Then you can order ScopeDome USB Card ver.2.0. When the card is ordered you can choose its additional option:

- Plug And Play wiring.

For Plug And Play wiring there is possibility to order additional:

- electronics and the motoreducers heating system.

The heating system is very helpful when the dome operates under severe winter and the temperatures below 0 C.

Starting from the end of 2013 there is simplified dome control system available:

- Semi Plug And Play (with no possibility to connect it to your PC).

ScopeDome dome typical order:

- ScopeDome 3M ver 3.0
- Door panel
- ScopeDome USB 2.0 Card System
- Plug And Play Wiring
- Dome Heating System

If you would like to calculate the final price of the dome you should sum up the prices of all the components using the pricelist listed on our WWW.

More information about our offer you can find here: <http://www.ScopeDome.com>.

Note:

All the prices given on our WWW are the net prices (without VAT). If you would like to buy the dome directly from us you have to add Polish 23% VAT rate (gross price). Remember about the shipment price that should be added to the final price. It depends on the distance between our manufacture and the customer site. Customers from outside EU can buy the dome with no VAT and pay this tax during its customs clearing.

A list of authorized ScopeDome domes dealers

We invite you to take a trip to our office in Slupsk. We will demonstrate our products with pleasure. It could be good opportunity to explain all the details about assembling the domes, designing your own observatory or adapting the existing building to become a functional astronomical station.

For all the customers who would not install the dome by them self we suggest to contact ScopeDome service team belonging to Nimax (Astroshop.pl). Their skills and experience are the guaranty that your project will be quickly and safely finished.

We invite you to read their blog, where they regularly post photographic reports from assembling of the next ScopeDome dome.

Similar support is available at our other dealers:

- Spain: (Astroimagen)
- Italy: (SkyPoint)
- Russia: (www.Astronom.ru)

The type of the observatory's building and its influence on the dome assembling process

The most important problem in the case of building the observatory is amount of free place around the base ring and the height that the dome should be installed on.

The building where the dome will be installed determines different ways of its assembling.

We can distinguish four different ways of construction and mounting the dome:

- 1.The observatory on the concrete slab in the garden.
- 2.The observatory on the wide roof, where the people can stand next to it during assembling process.
- 3.The observatory installed on the family house terrace.
- 4.Tower type observatory (with no access from the outside).

Ad 1. The most convenient and fastest (which does not mean that the best) is to build the dome in the garden on a concrete slab. Then there is no problem with mounting further rings near the base ring and entirely installing them on the previously assembled components. This is shown on the pictures attached to the manual.



Assembling the dome on the concrete slab in the garden

Fig. 1

Ad 2. This situation is similar to point no. 1. Usually, we will have to mount the dome segments directly on the ring base, or mount them entirely at ground level. Then lift it all by a crane onto the roof of the observatory. Choosing the best solution depends on the amount of space around the base ring.

Ad 3. Building your own observatory on the house terrace, keep in mind that the typical terraces are always inclined so that water flowed from them. For astronomical domes it is a big problem, they must be perfectly leveled. To solve this problem, simply order a special platform for leveling the slope of the terrace, allowing the support of the dome on its entire circumference.

Ad 4. This is by far the most complicated way to mount the dome. In this case, we advise mounting the base ring and the rotating ring directly on the tower. However, all the side panels of the dome is best to assemble at a ground level, and then place them by a crane on a rotating ring as you can see on the pictures.



Assembling the dome on the tower using a crane

Fig. 2



The dome on the gantry

Fig. 3

How to be prepared for installation of the dome

Prior to installation of the dome you should read the entire manual and familiarize yourself with pictures included on CDRom attached to the package.

After inserting the disc into the drive and run Autorun.exe you have a very helpful guide to the documentation of the dome. Photos and videos placed on CDRom illustrate a typical installation of the dome and show you step-by-step, what, how and in what order you should do.

We think that it will be very helpful to study three-dimensional model of the dome in 3D format, included on the disc. It allows you to view the dome in any plan and at any angle. You can study the individual elements of the dome in different rendering modes - for example transparent, with choosen surfaces, crossections, etc. To view the model of the dome there is a need to use the latest version of the free program [PDF Reader](#) from Adobe.

It is important that you understand each of the installation steps and have planned the time and organized the people needed to help. It is also important that each of the people working at the dome know what, why, and when to do a specific action.

ScopeDome 3M dome ver. 3.0 can be assembled by two people, but at the stage of setting and fixing the side panels to the base ring it is very useful to have a help of additional two persons. They are quite heavy so that require precise positioning on the prepared holes.

Prior to installation on the roof of the observatory please set a geographical directions north and south. You should also keep in mind that hard weather conditions (raining, strong wind, freezing) can make the installation impossible . In particular, it is not possible to mount the dome during strong wind, because its elements will simply fly on the site. Strongly disturbing will also be rain and temperatures below zero.

Please always keep in mind when installing about the necessary seals. If you forget any of them, then later it will be very difficult to repair.

With an efficient team and a well-prepared surface of the roof the dome can be assembled in one day (about 6 hours). The next day you can focus on assembling and testing all elements of the automation.

If you do not have any experience in connecting electrical and automation systems, we advise you to use the services of specialized companies or automation engineer who installs this type of devices every day.

Ordering Plug And Play wiring system significantly helps in the installation. Then you have to correctly connect only the main points of the dome power supply network.

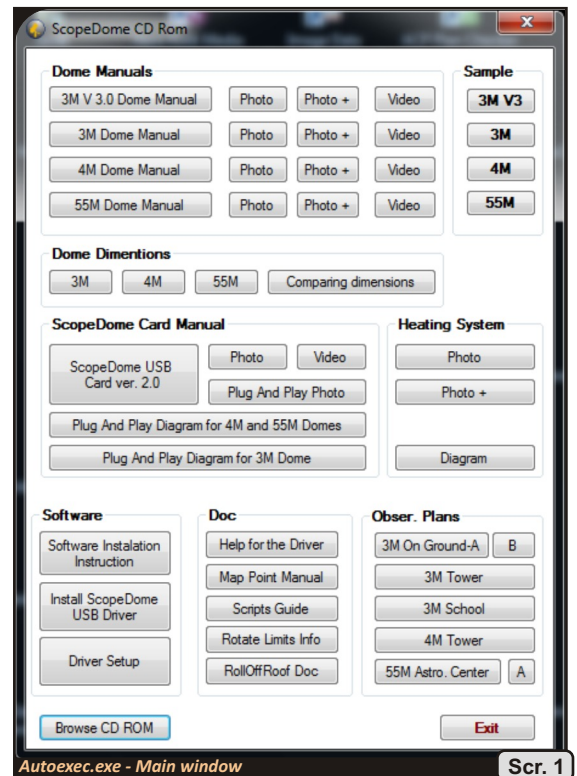

Autoexec.exe - Main window

Scr. 1

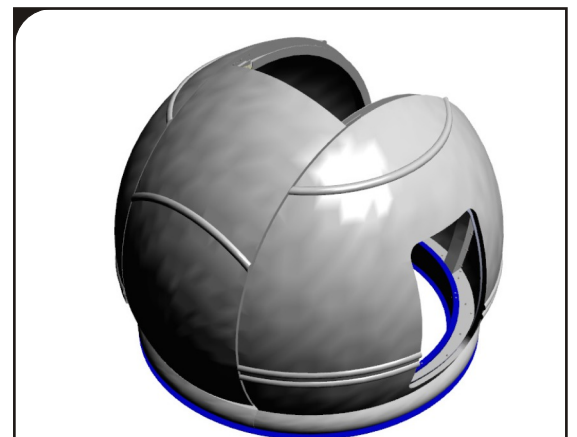

View of the dome model in 3D

Scr. 2

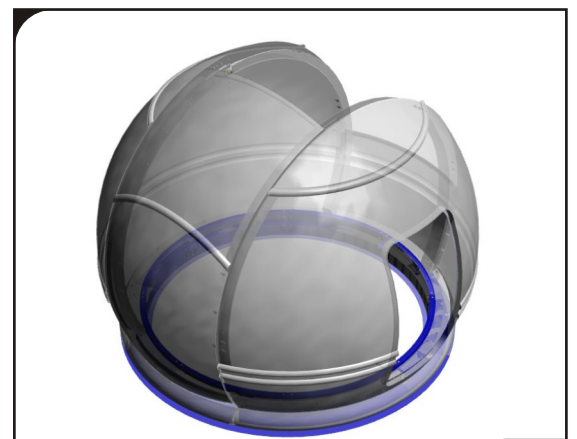

View of the dome model in 3D - transparent mode

Scr. 3

A list of necessary tools and materials

Tools:

- cross screwdriver (size: PH1 and PH2)
- small flat screwdriver for fixing electrical connectors
- hex key 3,0mm and 2.5 mm
- electric screwdriver (for measuring the phase)
- universal multimeter (voltage and resistance)
- keys 7, 10, 13 i 24 (common and click-type)
- driller and drills 7, 8, 10 mm
- steel and rubber hammer

Materials:

- Hilti M8 anchors – 16 items or other screws/bolts to fix the base ring to the observatory crown
- silicone sealant with holder - 8 tubes
- grease for the rolls (spytać się Janusza jaki)

Components of the dome and automatics system

For safe delivery to the customer the dome is wrapped by a few layers of thick thermal foil and packed on the wooden pallette.

Dimensions of the entire package:

L x W x H: 2800 x 2100 x 2280 mm
Weight (with the pallette): 365 kg

Components of the dome:

- base ring - 4 segments
- rotating ring - 4 segments
- reinforcement brackets - 7pcs.
- engine bracket - 1 pcs.
- outer cover - 4 segments
- inner cover - 4 segments
- side panels - 2 segments
- rear panel
- front panel
- shutter panel
- cover for the shutter gutters - 2 pcs.

Components of the automatics:

- rotation engine module
- rotation engine inverter
- shutter engine module
- shutter engine inverter
- Open and Close limit switches
- ScopeDome USB Card ver. 2.0 - main and rotary part
- Home Sensor
- Home Sensor diaphragme
- Thermometer 2x
- Hygrometer
- weather proof boxes for electronics
- electronics and motoreducers heating system

(technical drawings of the components are shown on the end of this manual)

The dome assembling sequence

Planning of the work



Base ring

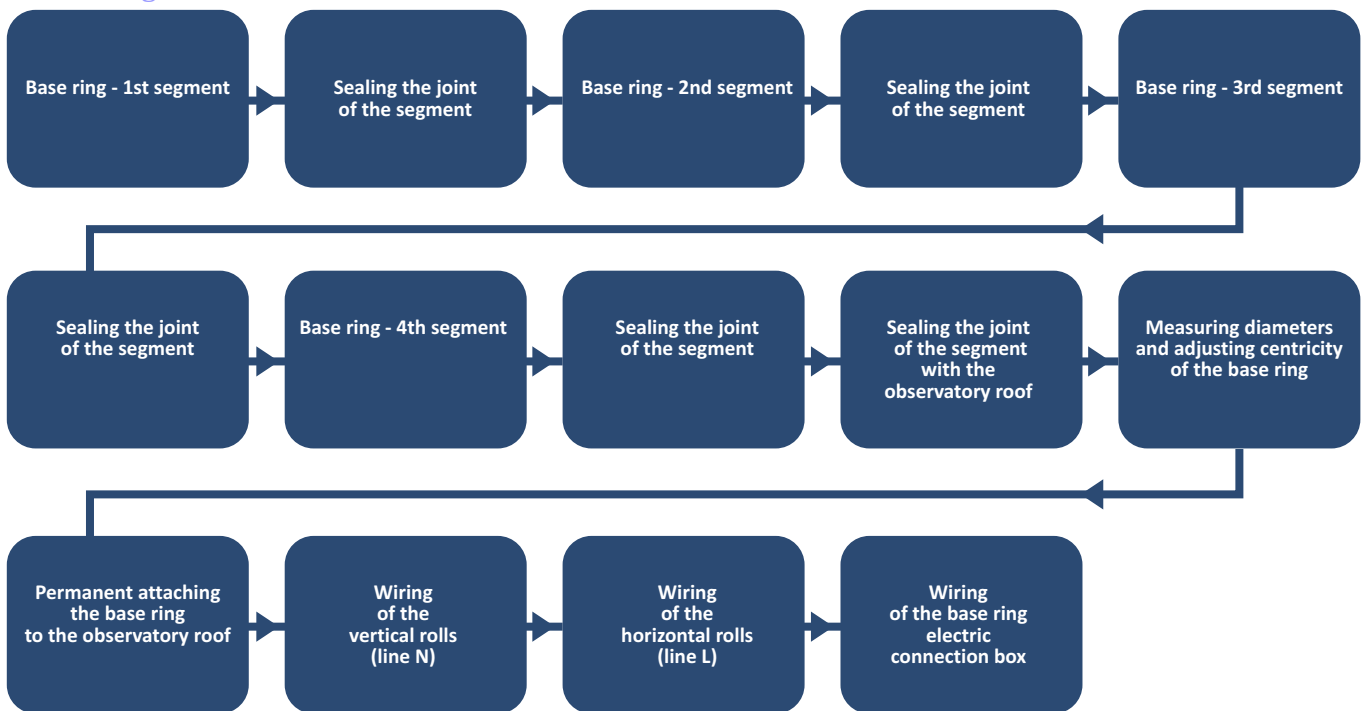

Rotating ring

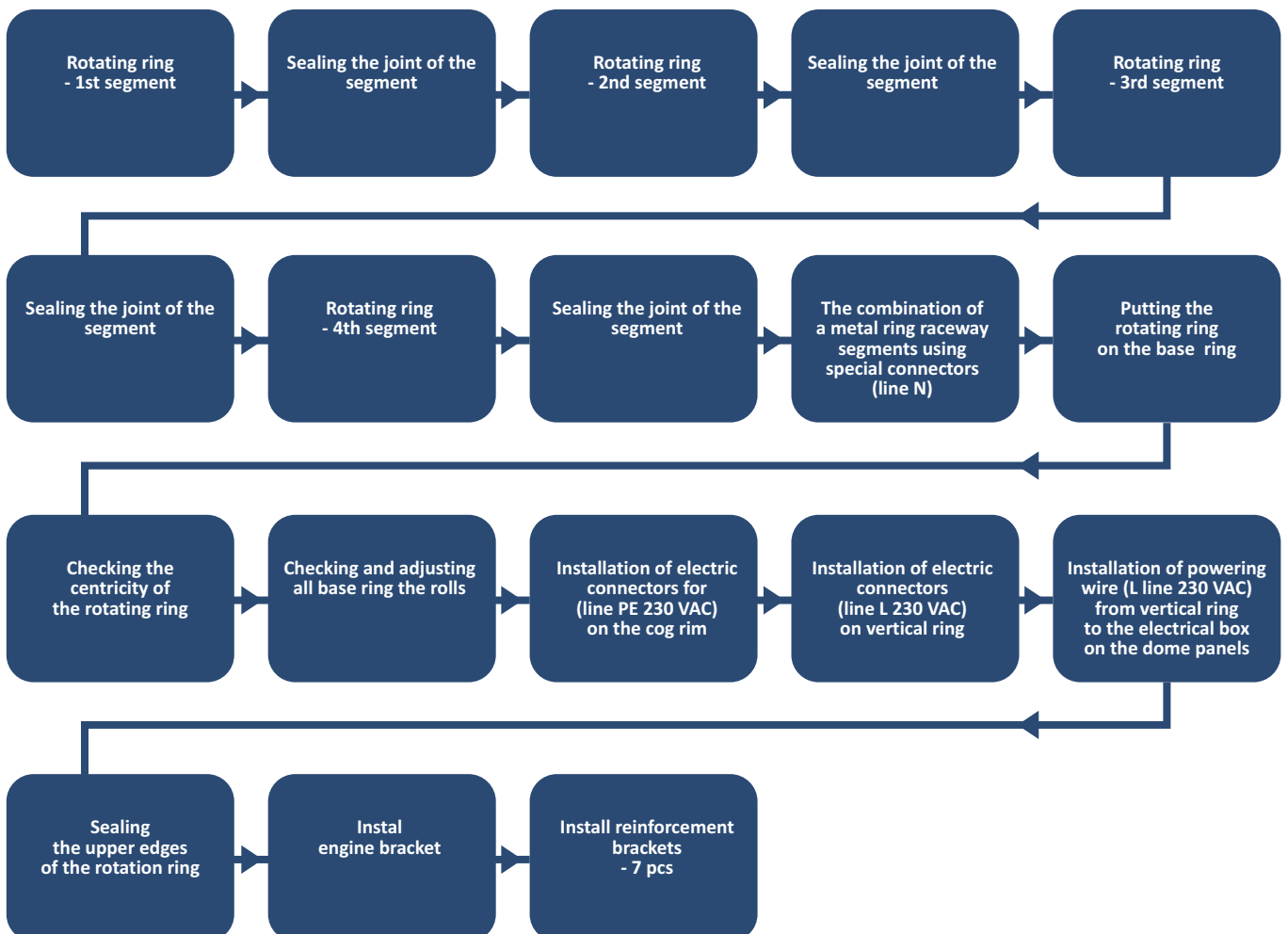

Outer covers

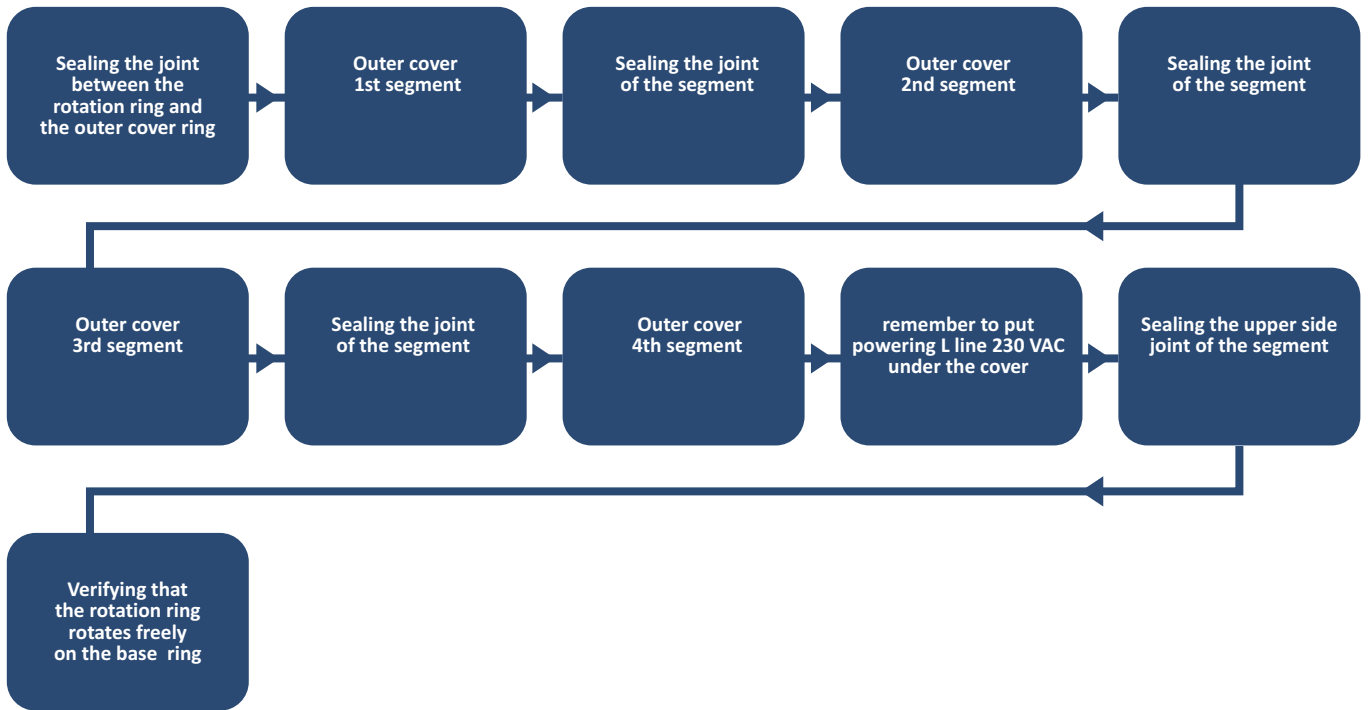

The dome panels

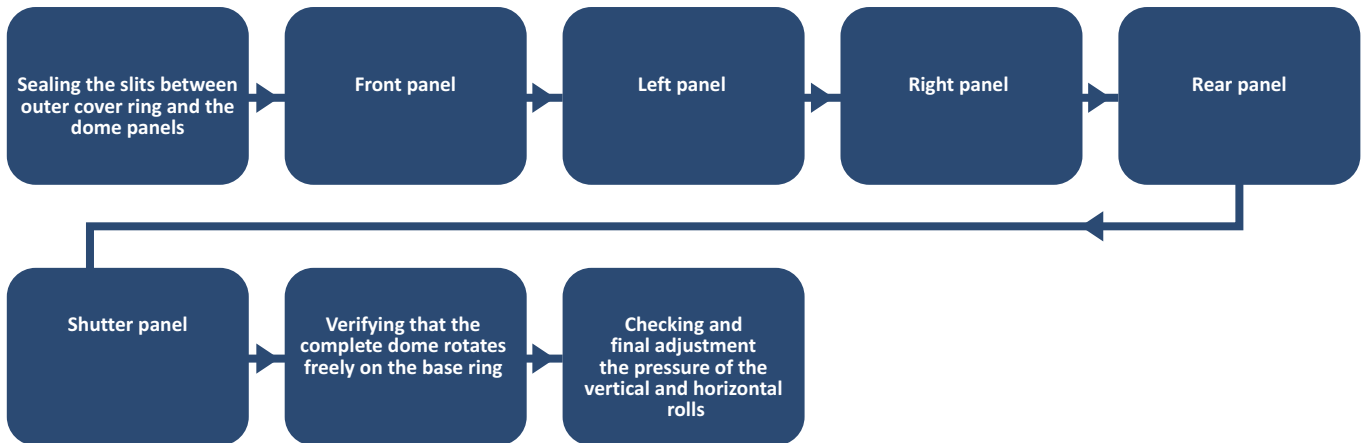

Inner covers

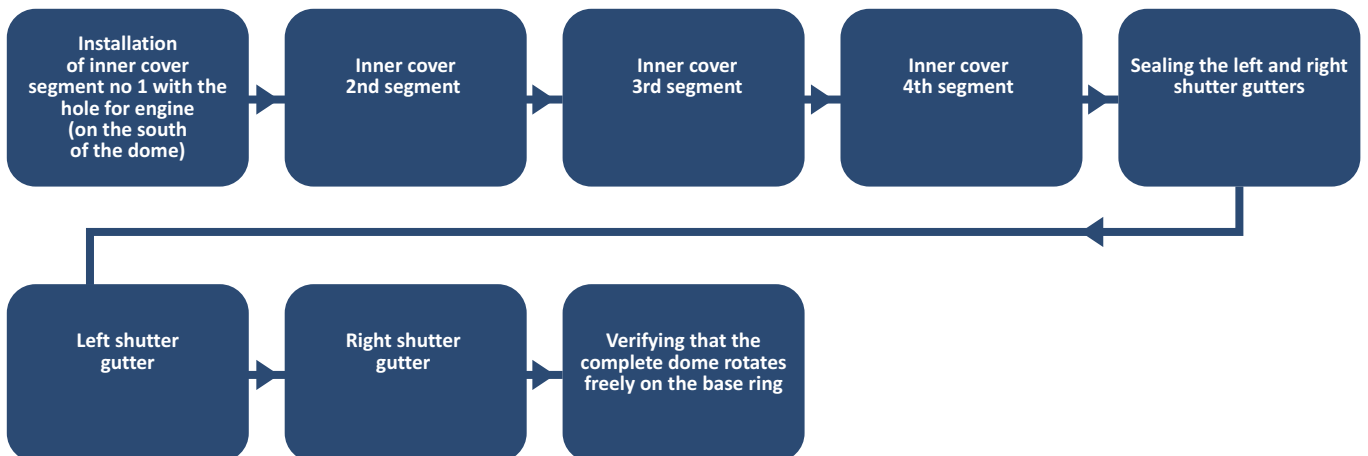

Sealing the joints of the panels

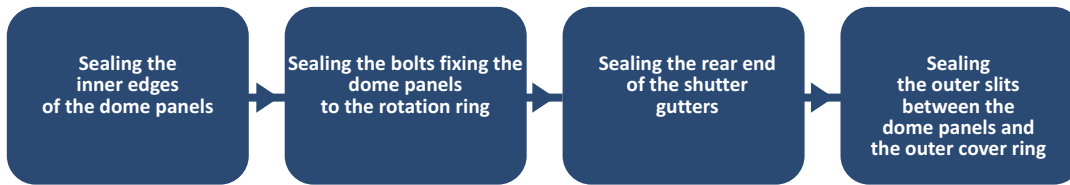

Installation ScopeDome USB card and the rotation drive

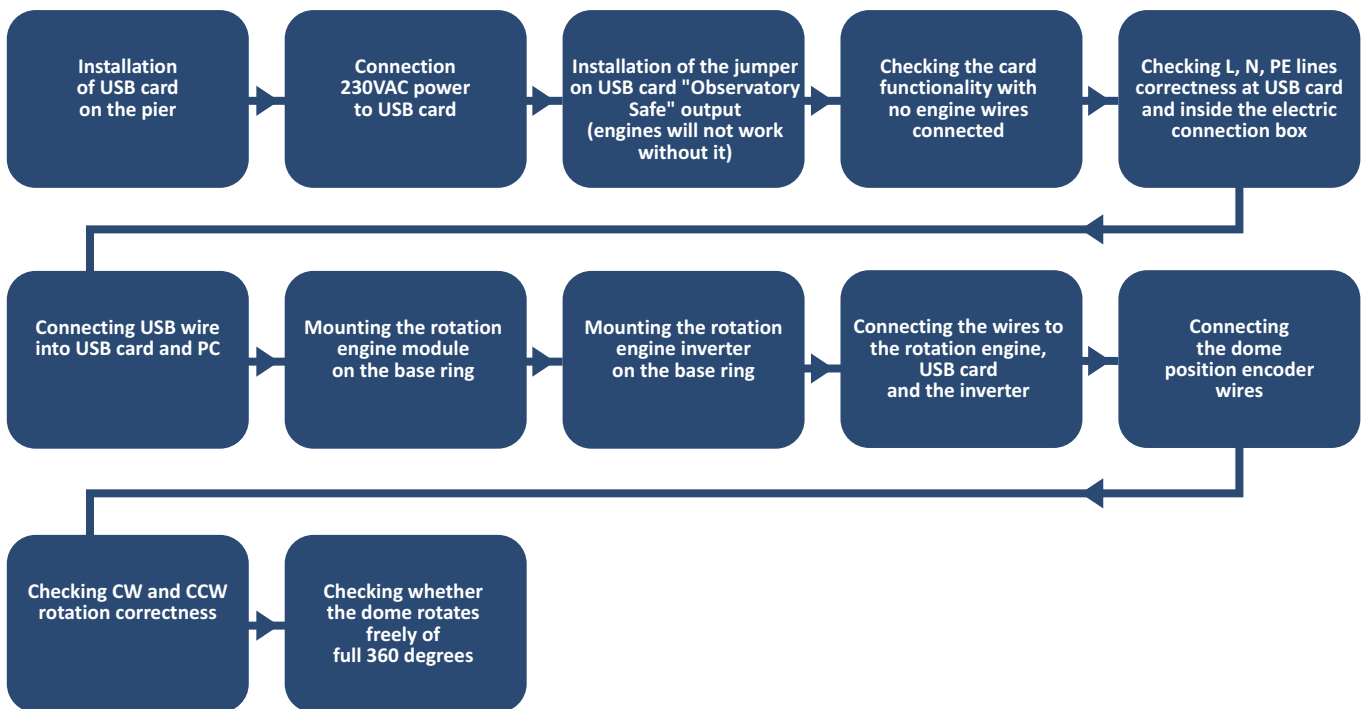

Installation of rotary part USB card and the shutter drive

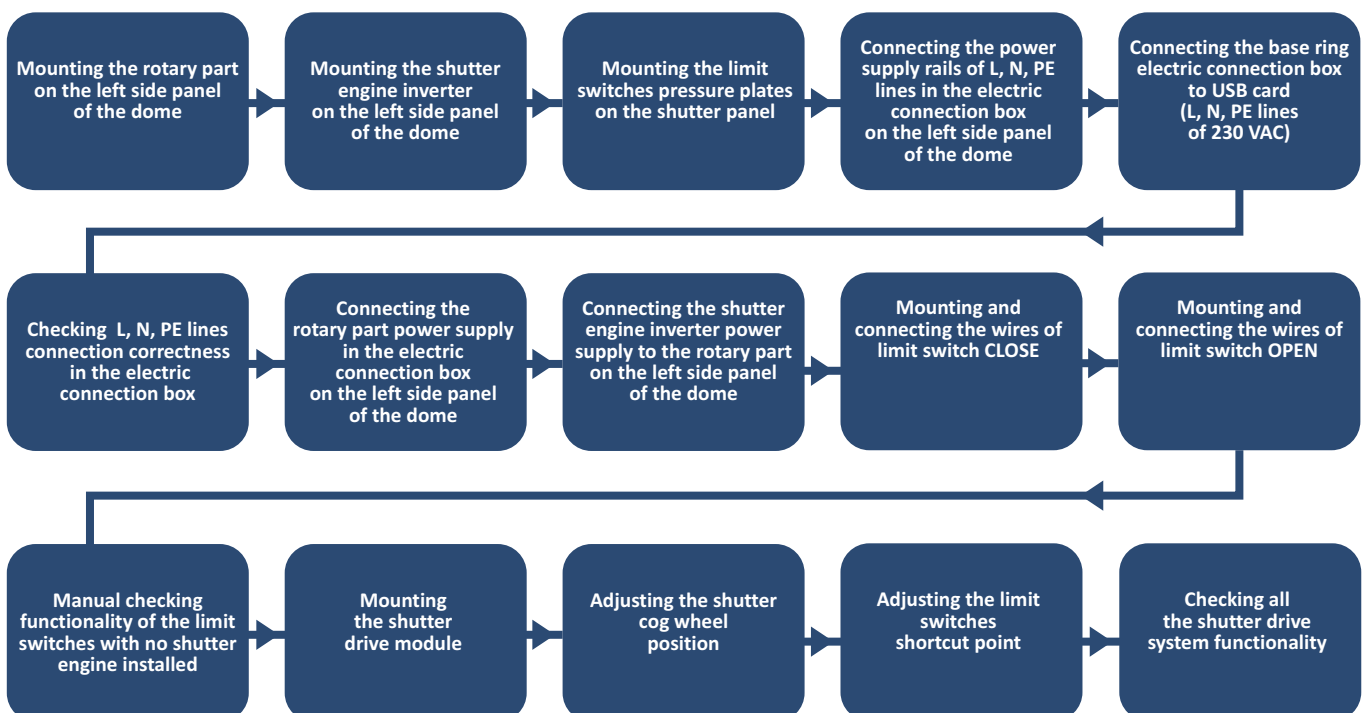

Installation of the software and testing the dome

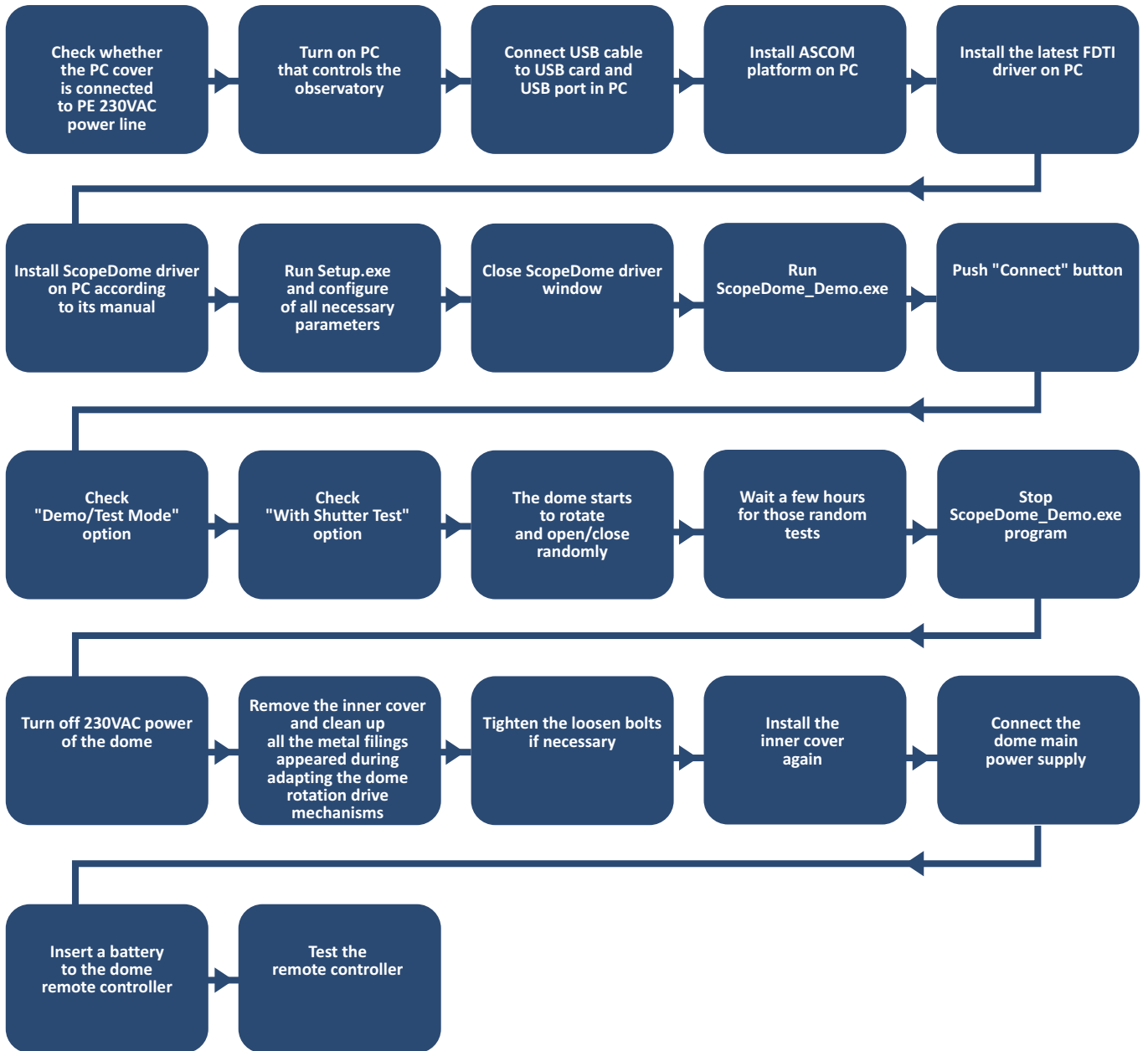

Base ring

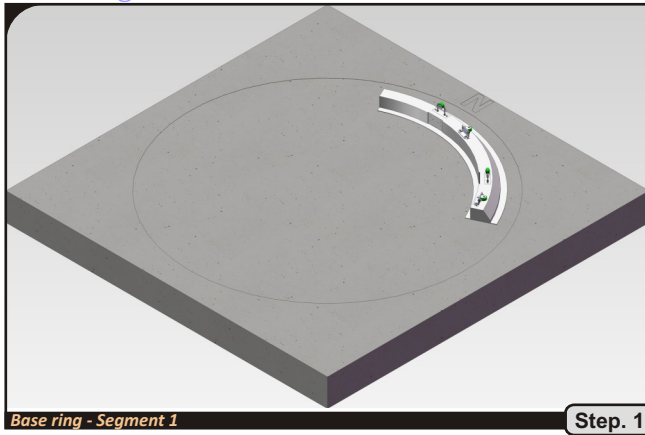

Base ring - Segment 1

Step. 1

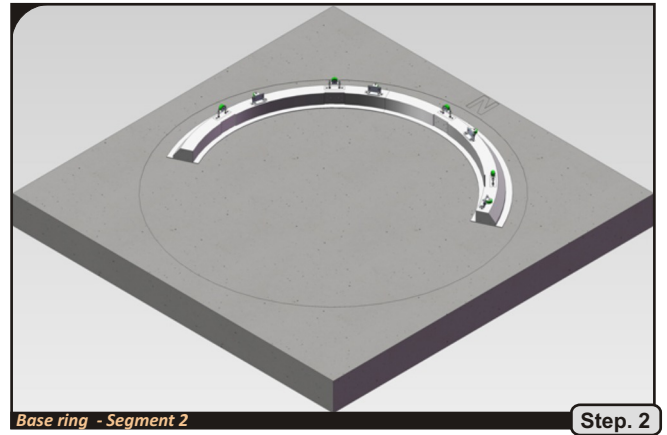

Base ring - Segment 2

Step. 2

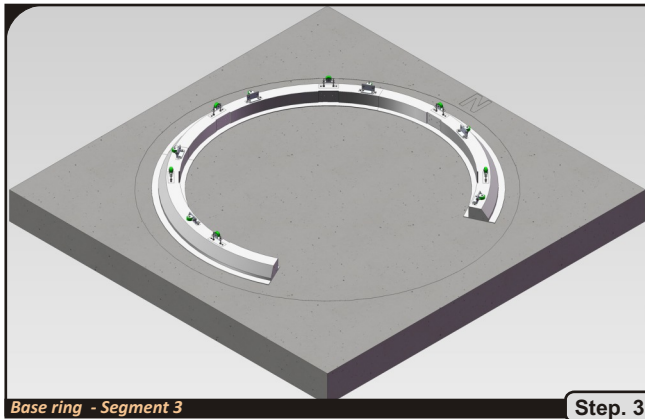

Base ring - Segment 3

Step. 3

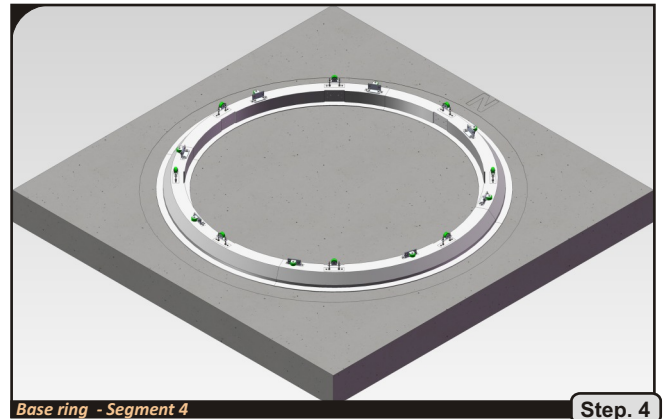

Base ring - Segment 4

Step. 4

Rotation ring

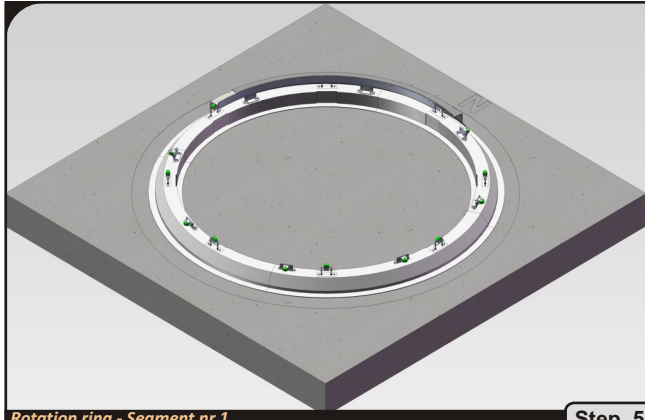

Rotation ring - Segment nr 1

Step. 5

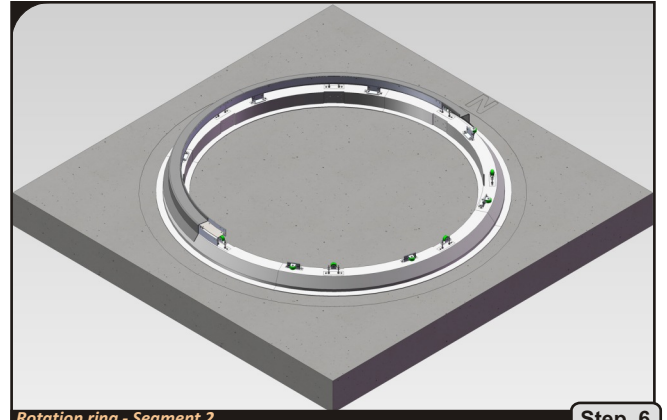

Rotation ring - Segment 2

Step. 6

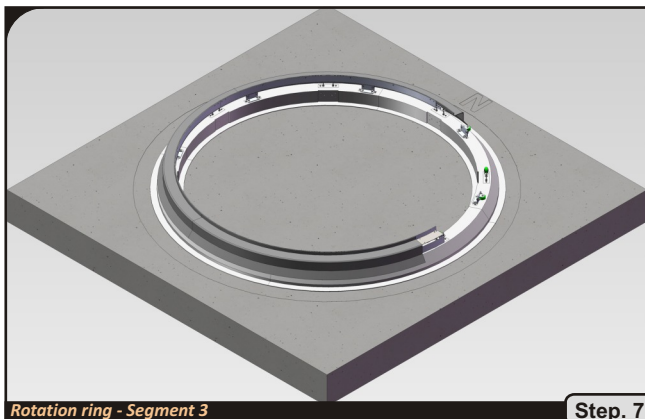

Rotation ring - Segment 3

Step. 7

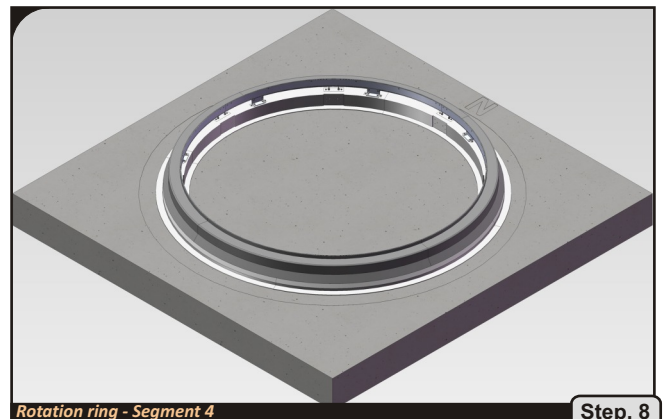

Rotation ring - Segment 4

Step. 8

Outer covers

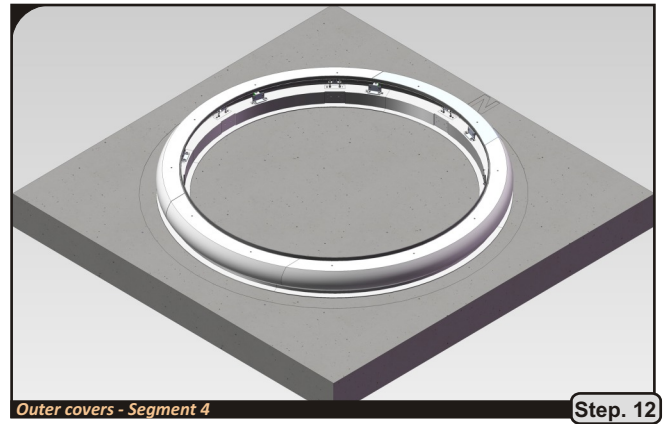
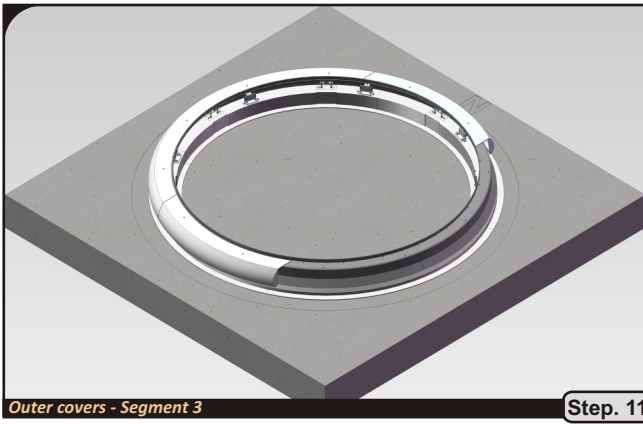
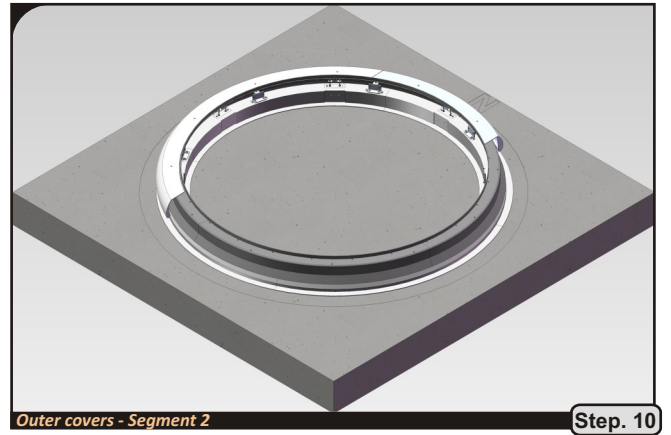
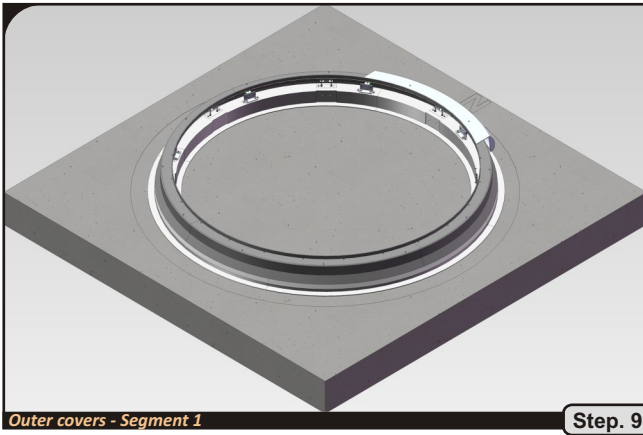

Reinforcement brackets

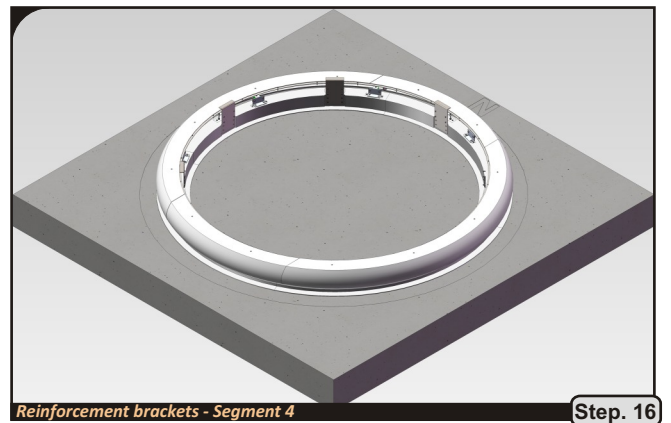
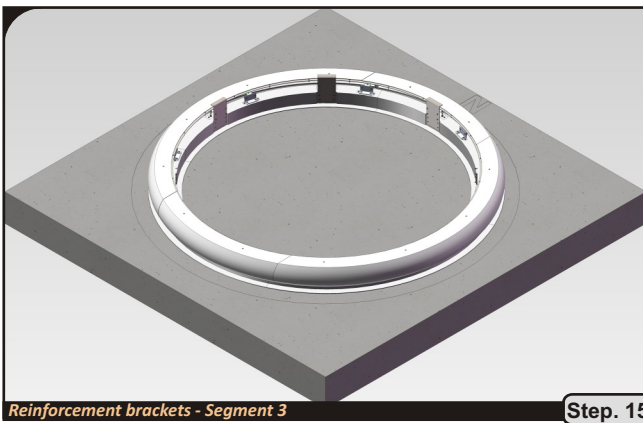
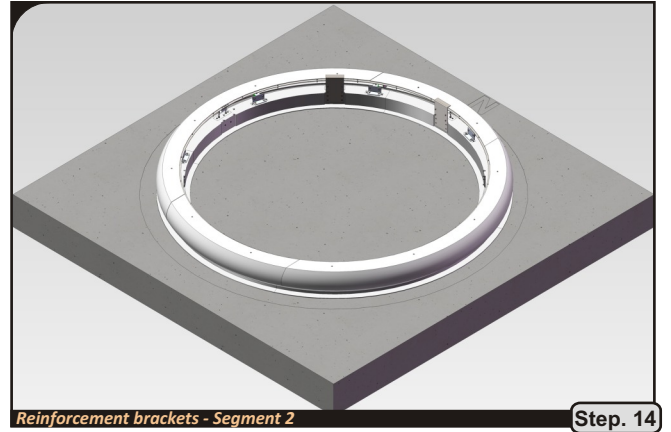
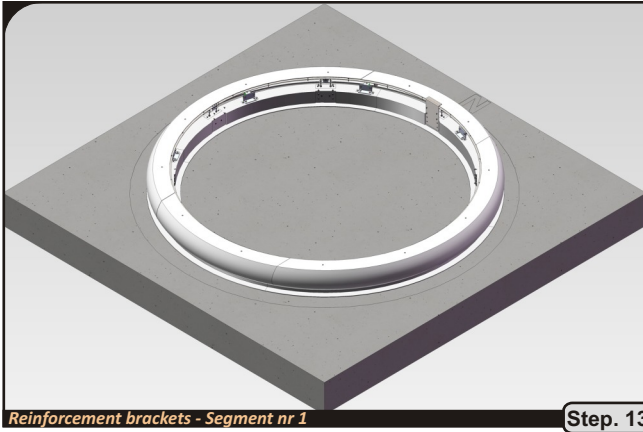

Reinforcement brackets

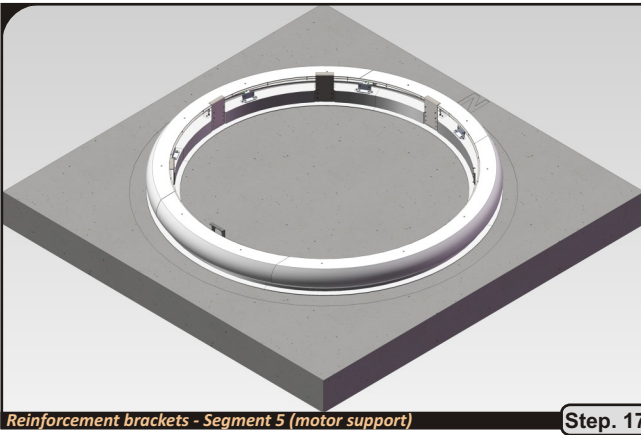

Step. 17

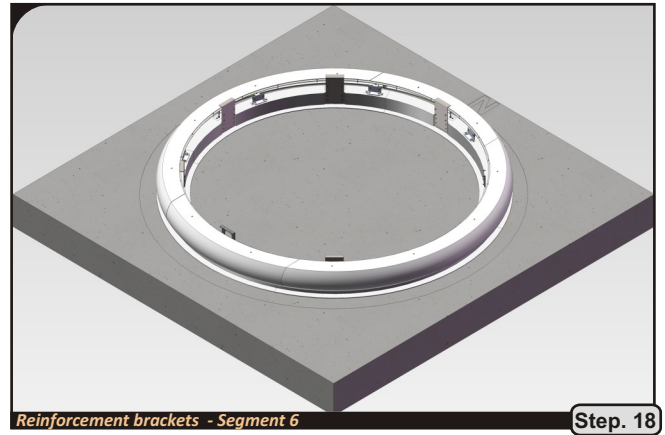

Step. 18

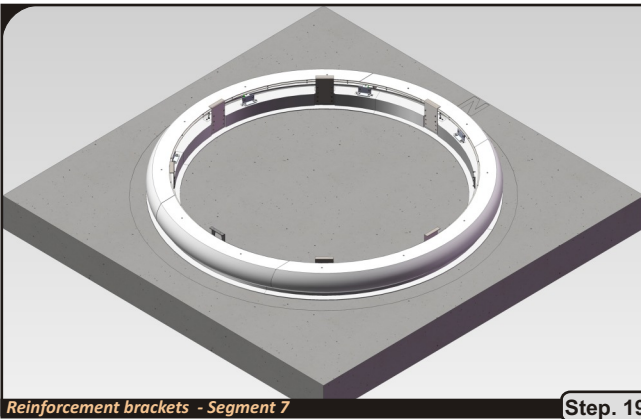

Step. 19

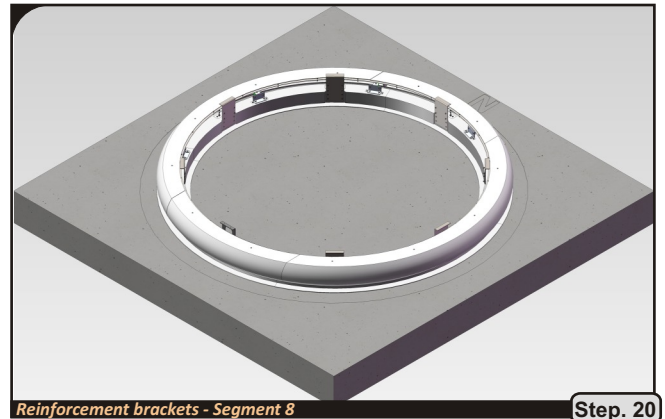

Step. 20

The dome panels

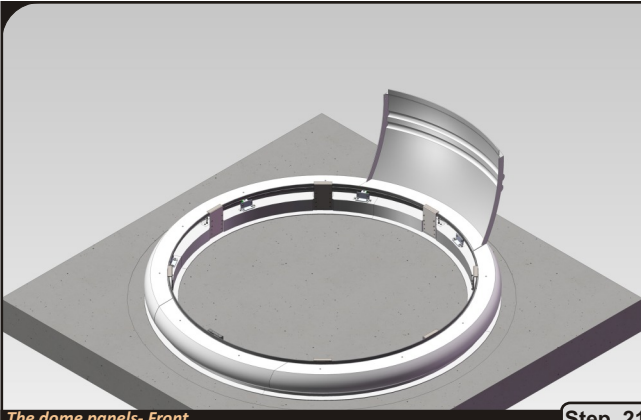

Step. 21

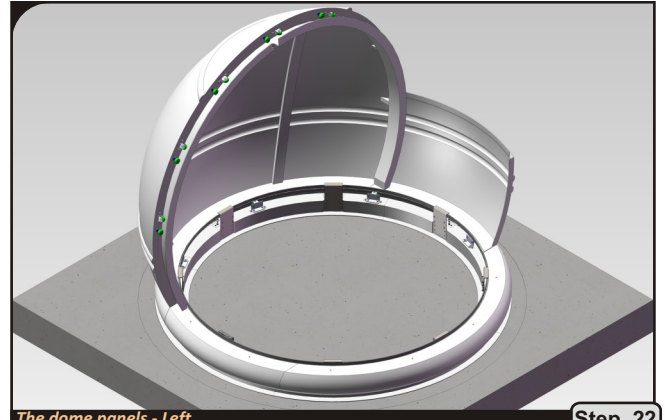

Step. 22

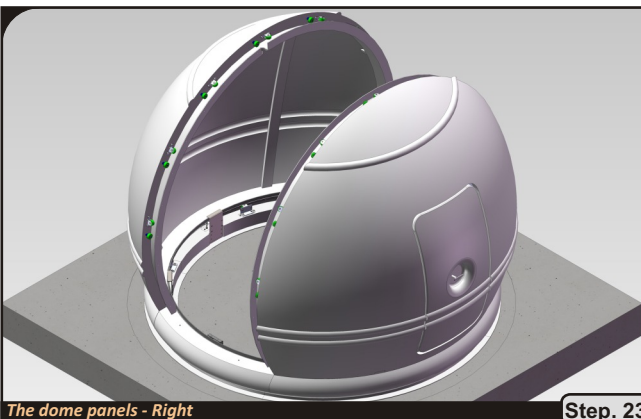

Step. 23

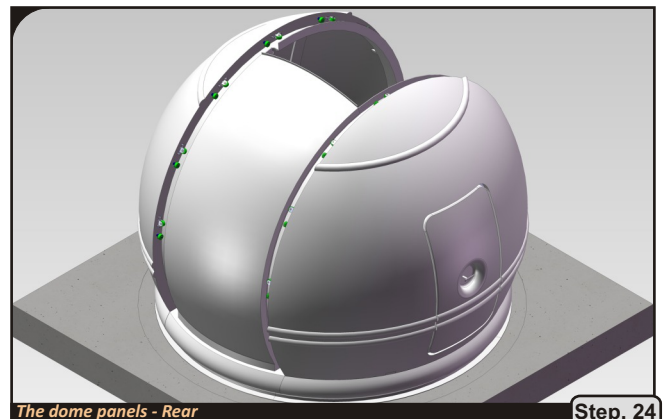

Step. 24

The dome panels

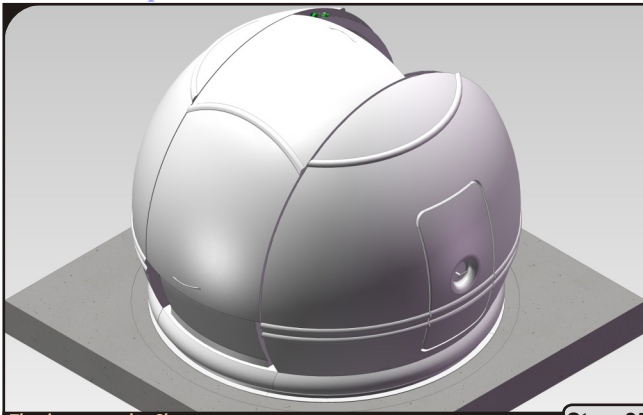

The dome panels - Shutter

Step. 25

Inner covers

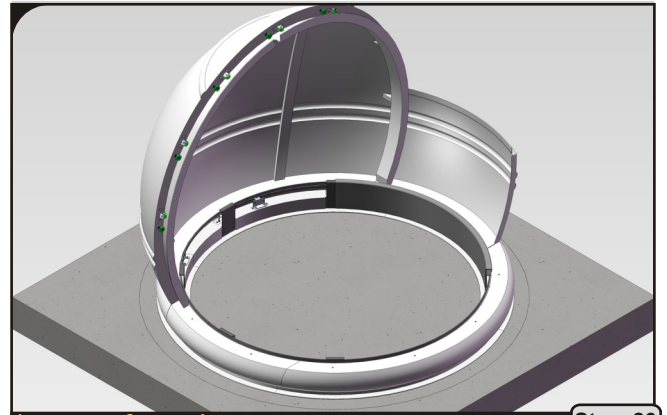

Inner covers - Segment 1

Step. 26

Inner covers

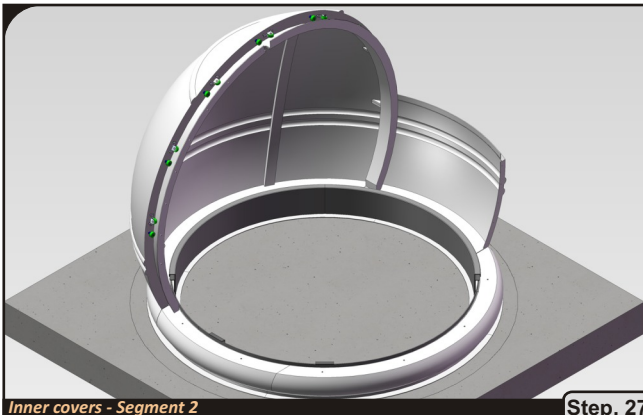

Inner covers - Segment 2

Step. 27

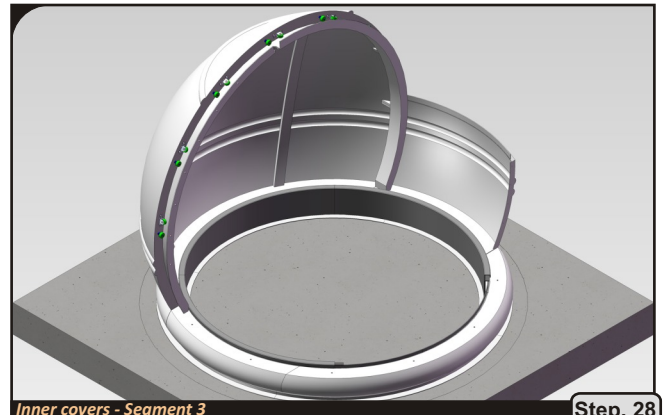

Inner covers - Segment 3

Step. 28

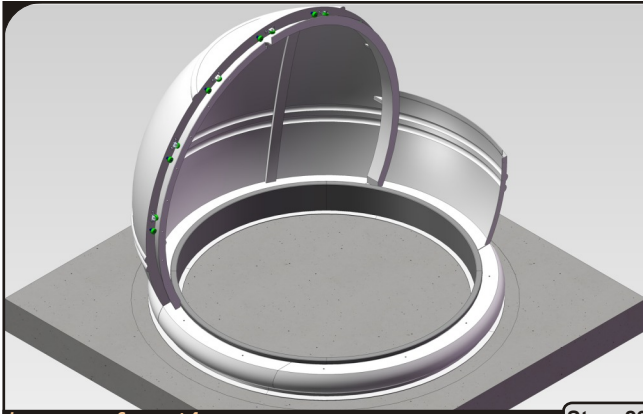

Inner covers - Segment 4

Step. 29

Limit switches

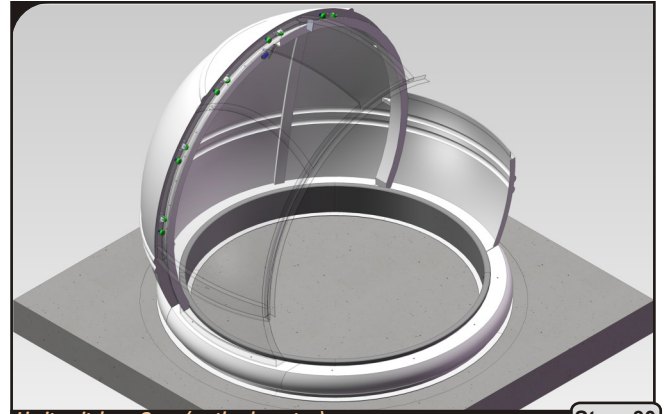

Limit switches - Open (on the dome top)

Step. 30

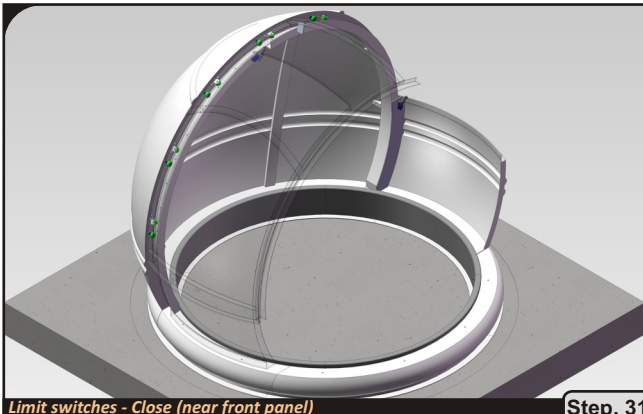

Limit switches - Close (near front panel)

Step. 31

Rotation and shutter engines

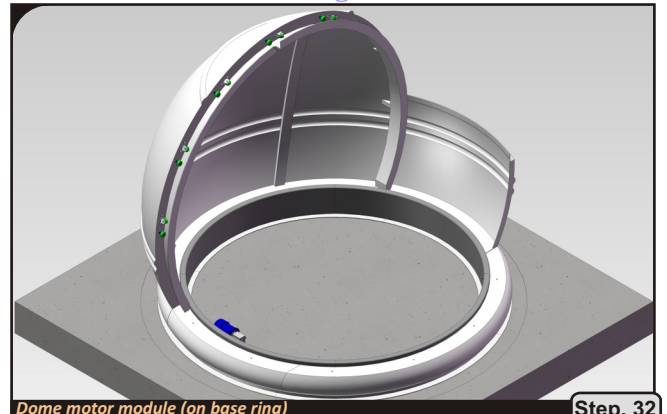

Dome motor module (on base ring)

Step. 32

Rotation and shutter engines

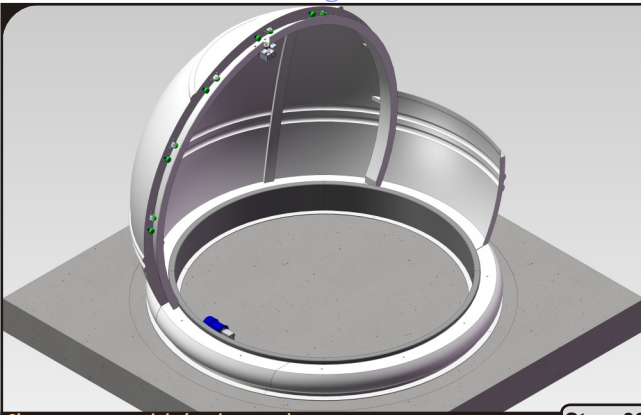

Shutter motor module (on dome top)

Step. 33

Preparing the roof for the dome assembling

Prior to installation of the dome you should take care of leveling the roof or concrete slab where the dome will be installed later. The slope should be checked at several points, and it should not exceed 0.1 degree. It is also important that the roof surface was smooth. Inequalities should not exceed 1 mm around the entire circumference of the base ring. The smooth surface of the roof will allow you to a tight seal of the dome base. Probably the easiest way to do this is to use a special self-leveling concrete eq. Ceresit CN 76 .

Sealings

To avoid leaking water at the observatory, all panel joints should be sealed with silicone during assembly. In particular, pay attention to the joints between panels of: the ring base, power ring, outer cover, and joints between the side panels of the outer cover. It should also be sealed from the outside all the slits those are visible at the base of the side panels.

To avoid the side panels getting dirty, before putting the silicone you must protect them with a painting tape. To seal the dome you will need about eight typical silicone tubes. It is best to use transparent roofing silicone eq. Soudal. You can buy it in Castorama or similar building markets.

Side joints of the base panels must be sealed before they are finally tightened. The joints between the base ring and a ring on the building should be sealed from the bottom by two strips of silicone.

All the joints of the rings segments should be sealed with silicone at both edges - inner and outer.

Drop of silicone should be put in every hole for the bolts (before they will be put in them) those connect side panels of the dome with its outer cover.

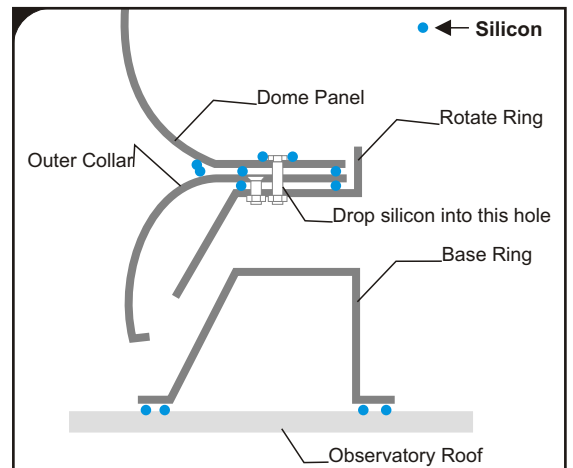

The dome sealing's scheme

Fig. 4

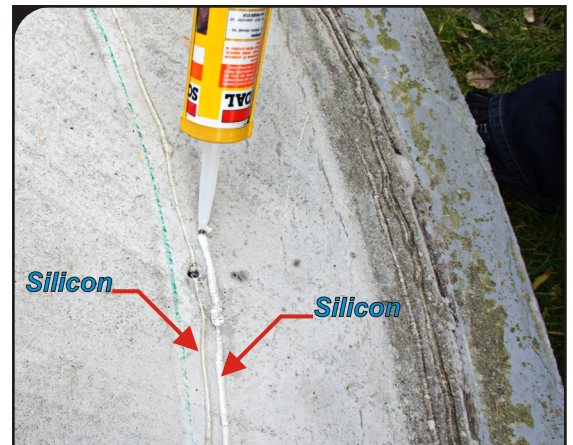

Sealing between the base ring and the concrete slab

Fig. 5



Sealing the side edges (joints) of the base ring segments

Fig. 6

Assembling and adjusting the base ring

The base ring together with the rotary ring are two key elements those decide about the dome proper functionality. It is very important to level them carefully and setting on common axis in that way to let the rotary ring rotate with no friction and resistance. The better you assemble and mount these elements the better dome will work later.

The base ring consists of four segments. Their sides (joint places) have to be screwed on with bolts to make a perfect circle. Sequence of the segments are marked on their inner side. Before permanent screwing on the segments their joint places should be sealed with silicone. Permanently screwed base ring has to be placed on the observatory's roof and centered in relation to the center of the observatory. There is a need to mark the north-south direction and adjust the base ring position so the rotation engine bracket is exactly at the south. Then you should outline the edges of the base ring on the roof and mark on the north-south direction.

At a distance of approximately 1 cm from the outlined edges, apply two strips of silicone on the surface of the roof and lay the base ring on them in a predetermined position.

Be sure to check out all the internal diameters of the base ring. They must be equal with accuracy of 2-3 mm. If they are not, then you should align the base ring using a rubber hammer, screwing previously one of the segments to the roof. Diameters should be checked at reinforcement bracket, opposite to vertical rotating rollers.

If the ring is centered, we can fix it to the roof of the observatory using eg 16 Hilti anchors of M8 size.

The next step is to connect with wires all the dome leading rollers and all the rotating rollers according to the following scheme.

The end of the cables must be placed to the inside of the base ring and connected to the dome rotating part power connection box. If you bought PlugAndPlay version of the automatics, all the wires should be joined in the box according to their colors.



Measuring the inner diameter of the base ring at several positions

Fig. 7



Hilti anchor

Fig. 8



Tightening Hilti anchor

Fig. 9

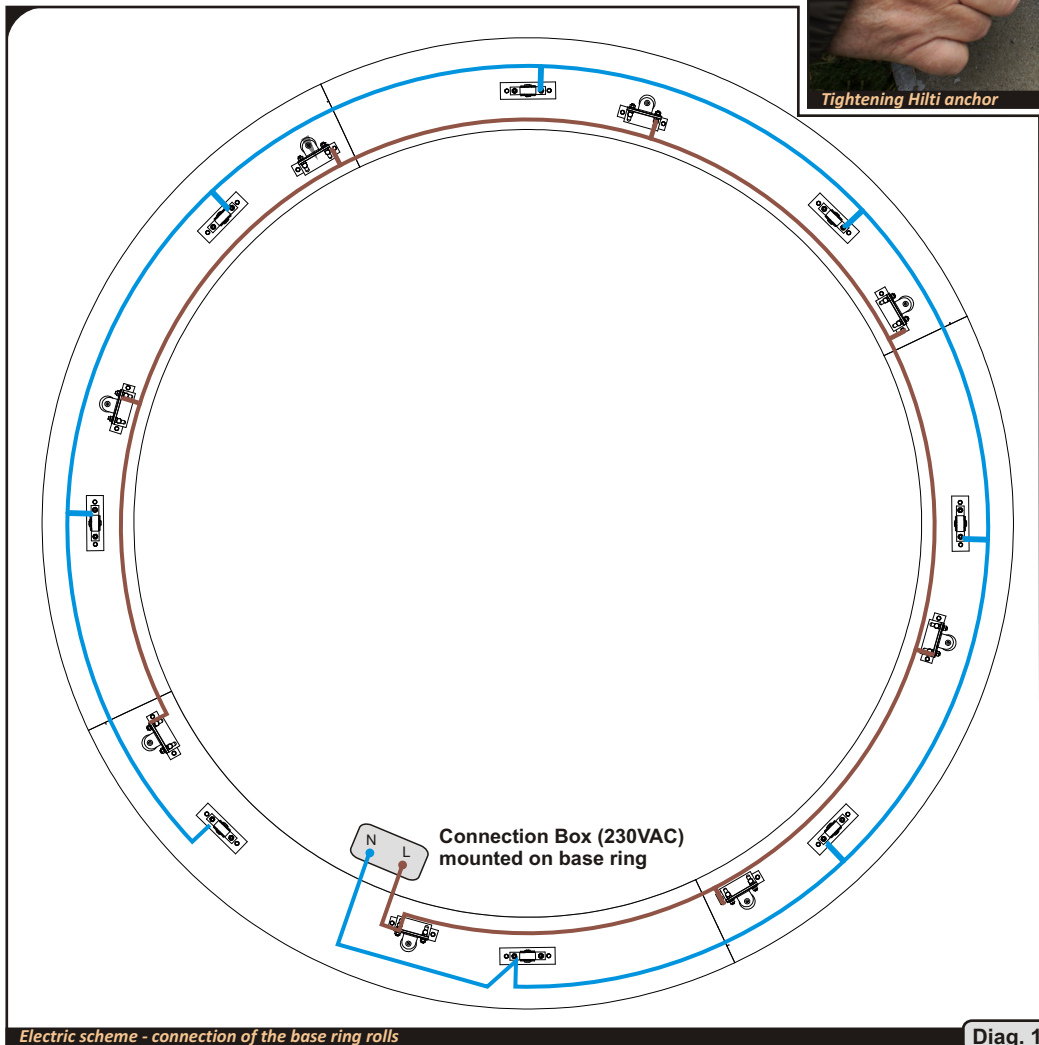

Electric scheme - connection of the base ring rolls

Diag. 1

Assembling and adjusting the rotary ring

The rotary ring consists of four segments. Their sides (joint places) have to be screwed on with three bolts to make a perfect circle. Sequence of the segments are marked on their inner side. Before permanent screwing on the segments their joint places should be sealed with silicone. After that you have to put a silicone on the joints on the upper side of the ring. Additionally on the entire circumference - one strip of silicone on the outer edge and the second strip of silicone in the place where the outer cover begins.

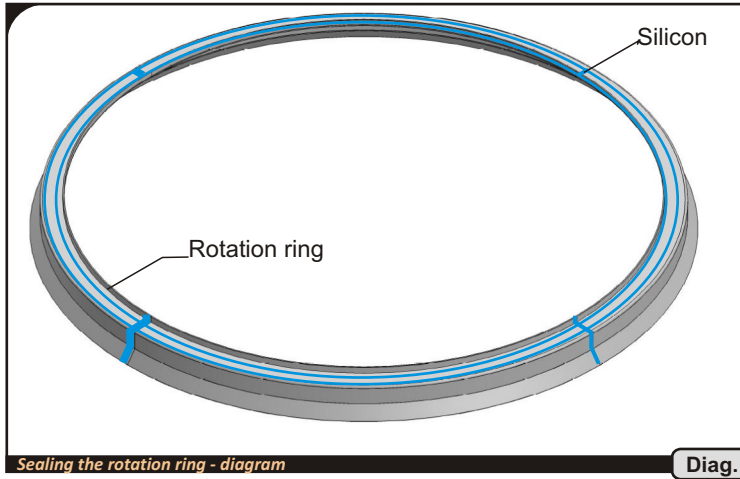

Sealing the rotation ring - diagram

Diag. 2

On the joints you have to screw jumpers those connect power rings. Vertical lath (line L 230VAC) is connected with three jumpers from the brown wire. Cog rim lath (PE line 230VAC) should be connected with the jumpers from the green wire. Horizontal driving ring should be connected underside with the jumpers made of aluminum.

Always remember to place the brown wire (line L) into the interior of the dome. It will be passed under all panels, and at the next stage of the installation there will be no access to it.

Installation of all 230VAC electrical wiring should be performed by a qualified electrician.

After wiring, be sure to check with a multimeter if there is a short circuit in the dome power supply lines and is there an electrical connection between all the corresponding rollers.

Thus prepared rotary ring we put on the base ring and check if it rotates freely. To check it, please simply rotate the ring several times. Also check that all the rollers adhere to the aluminum driving laths. If one of them does not touch the ring, you should make the necessary adjustments. You should also check the gap between the base ring and the rotary ring on the outer edge of the rotary ring. Around the perimeter of the ring the gap should be equal and have a size of about 5 mm.

In any case, the rotary ring can not rub on the base ring. If so, loosen the screws that hold the side rollers, turn the ring to set it in the correct position, then tighten the side rolls, pushing it to a vertical aluminum lath.

Adjustment of the ring position in the horizontal direction is easiest to perform in the manner described below:

- loosen the screws that holds the horizontal rolls into the ring base
- rotate the ring until it becomes centered on the ring base
- press in sequence every two opposing horizontal rollers to aluminum vertical power ring
- tighten the mounting screws.

After assembly, all the ring rollers should be greased.

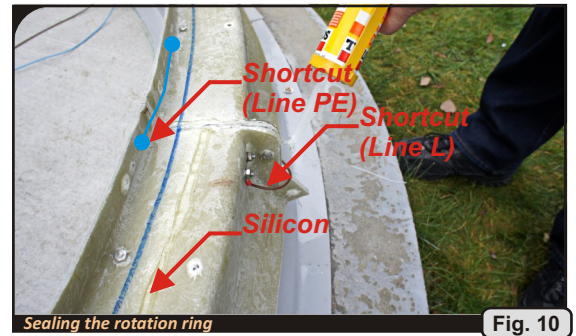

Sealing the rotation ring

Fig. 10

Mounting the reinforcement brackets

The next step is to tighten the eight reinforcement brackets using countersunk screws. These brackets protect the dome before lifting it up by strong winds. In addition, they are used for fixing the inner covers. On one of the brackets (with a large hole in the middle) we mount the rotary drive module later.

After mounting these brackets, make sure that none of them rub against the top edge of the rotating ring. If so, adjust the height of the base ring vertical rollers. While adjusting the rollers you should always check whether the rotary ring does not touch anywhere on the base ring.

Mounting the outer cover

This is the last moment when we have access to the cable connected to the vertical power lath. Be sure to arrange it so that its end was inside the dome. The cable will be placed under the outer cover ring.

The ring segments should be screwed using two bolts per one segment. Sequence of the segments are marked on their inner side. Shorter segments will determine the front and back of the dome. On longer segments the dome side panels will be mounted later.

Joints of each segment should be sealed with silicone before screwing them on. Screwed ring should be put on the rotary ring and set in such position to match all its mounting holes and numbers on the rotary ring. At the end you should screw cover ring to the rotary ring of using countersunk screws.

Before mounting the outer cover ring on the rotary ring, be sure to put two silicone stripes those will seal these two rings. After installation you must seal all visible slits and joints of the segments.

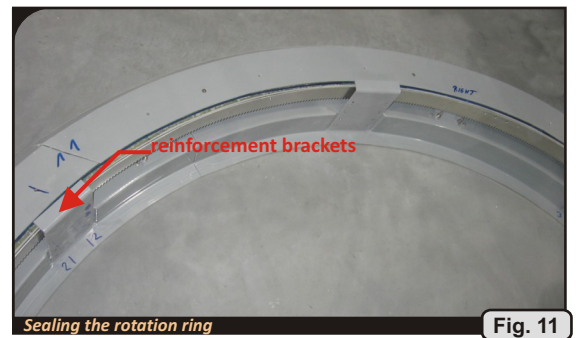
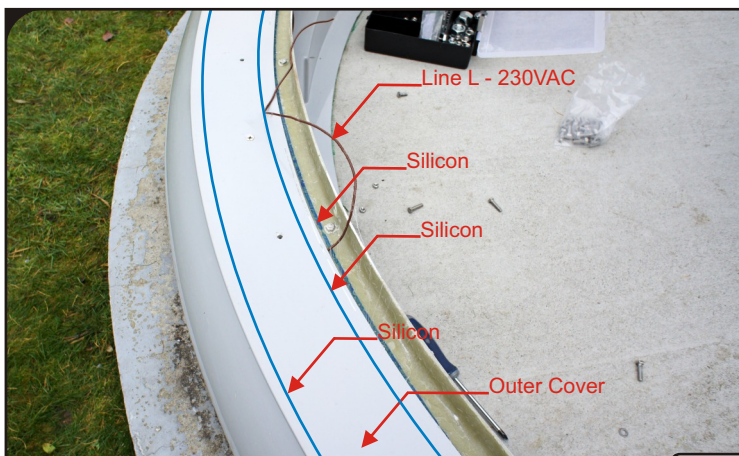

Fig. 11



Outer cover ring sealing scheme

Diag. 3

Mounting the dome panels

In the previous steps we have prepared a complete rotating ring of the dome, which is the basis on which we will mount the main elements of the dome: front panel, side panels, rear panel and the shutter. Now use a little help of additional two strong people. This will facilitate accurate, fast and safe positioning of the side panels on the rotary ring.

Before installing the dome fiber glass panels on the rotary ring please put two silicone stripes on the outer cover ring on directly where the dome panel will be mounted - one on the inner side, the second on the outer side of the panel bottom edge. Sides (joint places with other fiber glass panel) of each fiber glass panel should be sealed too. Before putting the bolts in the holes and screwing them on please put a drop of silicone to each hole. This prevents leakage of water condensing on the walls of the dome through the holes for the bolts.

We start mounting from the front panel. We mount it on the short segment of the outer cover according to numbers visible on the panels. There is no need to permanently screw on the bolts now. On this stage you can only put the bolts in the holes. This will facilitate the positioning of successive side segments in the holes. Now, we attach the left side panel to the front panel, put it on the holes screw it on with the front panel and put the bolts in the holes. Right side panel should be mounted analogously. Finally we put the rear panel on the ring, connect it with bolts with two side panels. Outer bottom edges of the panels should match with the edge of the outer cover ring.

If some of the hole in the main dome panel does not allow to put the bolt in, simply drill out it using a drill with diameter of 8mm.

When all of the dome segments fit and match together we can permanently tighten them to the rotary ring. **Under one of the bolts close to electric connection box you should connect the shutter white N line power cable.**

Mounting the shutter

Before putting the shutter on you have to install upper limit switch (Open Sensor) on the top of the dome. If you ordered the shutter drive system you have to mount the shutter engine bracket at the moment. If you put the shutter before it then you will have difficult access to this place.

Before you put the shutter on the dome please screw on the handles on its ends. These handles are used for manual opening/closing the shutter. Before you put the shutter on the dome you have to grease all its rolls.

The shutter panel should be put on dome from its back side. Before you do it, please dismantle three sets of the rolls on the dome back side. After putting the shutter on and closing it these three sets of rolls should be installed again on their proper places.

Attention! The shutter moves very smoothly. During manual opening/closing it has to be supported by a hand from the front and the back so when it is falling it will not hit the front or rear panel.

Mounting the inner cover

The segments of the inner cover should be screwed on into the side brackets using raised head screws with cross. Pay attention to the segment where the rotation engine will be mounted later and screw it in right place. This segment have a hole for the drive cog wheel.

If the dome rotates freely and all the rollers are properly pressed into the aluminum rings, we can mount the inner cover segments on the side brackets. Before mounting the inner cover it is worth pre-install the rotary engine and check the position of the cog wheel. After installing the inner cover looking at on the cog rim will be very limited. You should also check that all the rolls and side brackets bolts are tightened. If any of the screws are loose, it should be tightened.



Shutter electric connection box

Fig. 12



Place where the main shutter engine bracket should be mounted

Fig. 13



Putting the shutter on the dome

Fig. 14



Putting the shutter on the dome

Fig. 15



The dome with inner cover segments installed

Fig. 16

Installation of the shutter gutters covers

There are specially designed gutters of water draining system in the front of the dome. During huge raining it is sure that a lot of water will flow there. To protect the dome against leaking there is a need to install additional covers on the gutters at the front panel of the dome. The covers should be fixed using three screws. Before mounting them the entire surface of the gutters should be covered with a silicone. In addition, it is necessary to seal the joints between these covers and the dome front panel.

After installing additional shutter gutter covers you have to install bottom limit switch (Close Sensor) using the existing holes.

The final sealing of the dome

After installing and testing the dome you have to seal from outside all the edges and joints placed of the fiber glass panels with the outer cover and the base ring with the observatory roof. Especially pay attention to seal the rear ends of the shutter gutters. Generally there is a need to seal all the slits visible from outside and inside. Additionally put the silicone on the ends of joints between the segments of the rotary ring, outer cover ring and the dome side panels.

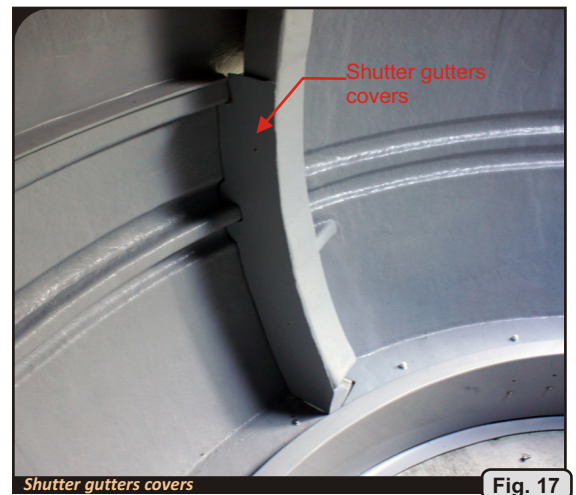

The dome shutter power supply system

Powering of the shutter is provided by following elements:

Stationary part:

- electric connection box at the base ring
- vertical rolls (line N)
- horizontal rolls (line L)
- rotary engine chassis and the cog wheel (line PE)

Rotary part:

- aluminum horizontal ring (line N)
- aluminum vertical ring (line L)
- rotary drive cog rim (line PE)
- electric connection box at the bottom of the left side of the dome

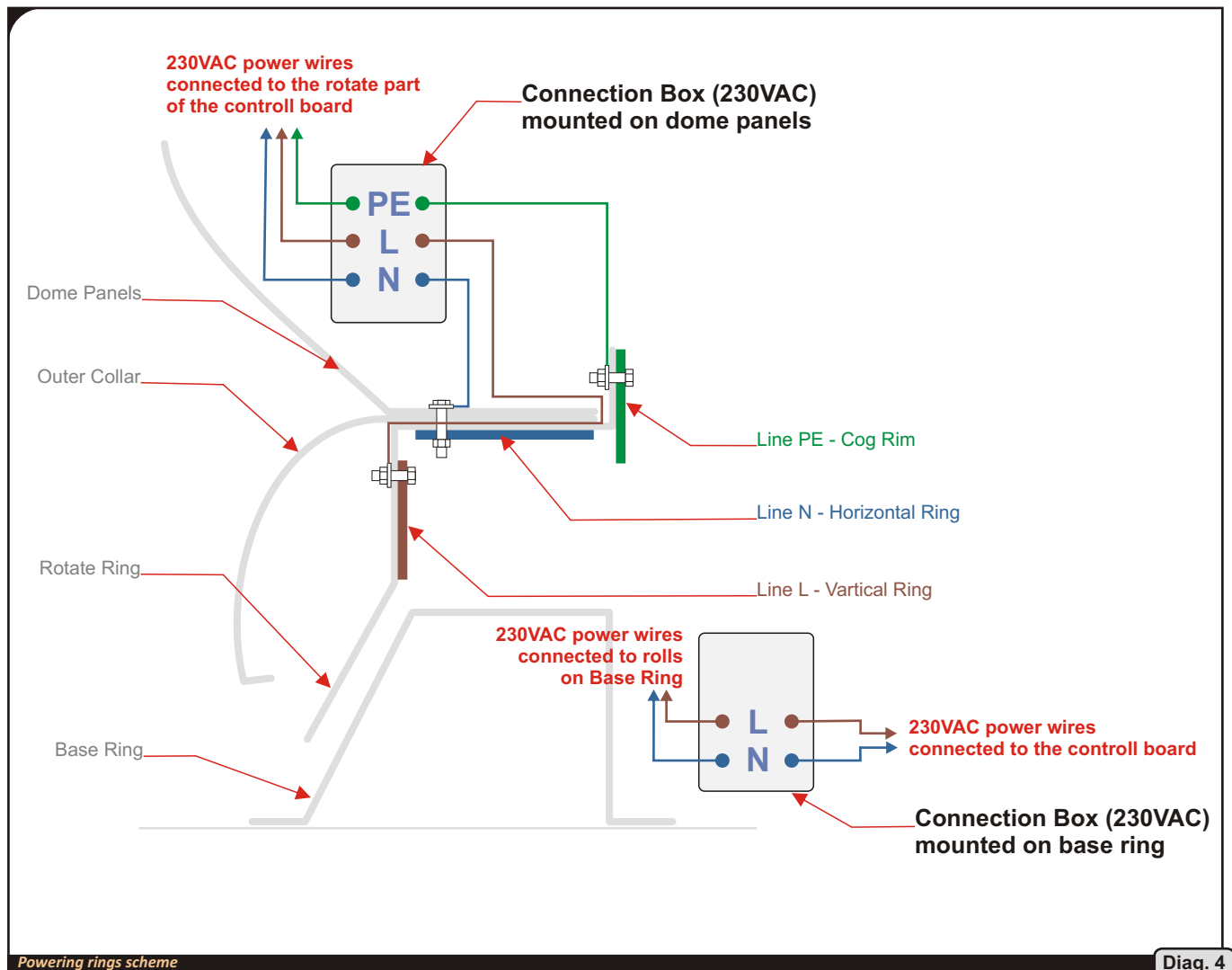

Installation of all 230VAC electrical wiring should be performed by a qualified electrician.

Check that all the rollers adhere (press) to the aluminum driving laths. There is a need to have electrical connection between aluminum segments of the vertical and horizontal rings and the cog rim of the rotary drive.

The wires in the electric connection boxes should be connected according to color: PE- green, L - brown, N - white (we use blue instead of white on the schemes because the white is invisible)

Installation of the dome drives and automatics

Installation of the rotary drive system

After installation of the inner cover panels we can install the rotary engine module and fix it to the side bracket. Rotary engine should be installed exactly on the bracket that is located at the south on the base ring. Please check if the cog rim lath is placed in the middle of the cog wheel width. If not, make adjustment of the axis using two blocking nuts. To have free access to the nut on the end of the axis there is a need to dismantle the encoder cover.

Installation of the limit switch's

Before installing the shutter drive there is a need to install limit switches with pressure plates at their marked places on the top and the bottom of the observation window. The arm of the limit switch should be adjusted in such way to make it active about 1 cm before full closing/opening the shutter.

Installation of the shutter drive system

The shutter engine should be fix to its main bracket o the top of the dome. The cog wheel should be set so the cog rim is in the half of its width. The cog wheel should be strongly pressed to the cog rim.

Installation of the diaphragm and Home Sensor

Home Sensor should be installed on the side bracket where the rotary engine is attached. Home Sensor should be set in the position maximally to the center of the dome. Diaphragm should be screwed on to two holes placed at the bottom of the rear panel. Then it should be bend in such way so its end freely passes through Home Sensor slit.

Installation of ScopeDome USB v.2.0 card system - main part, rotary part and inverters

The main part of the card should be installed on the pier. The rotary part should be installed on marked place on the dome side panel. If you ordered Plug And Play wiring then the rotary engine inverter is placed in weather proof box. It should be attached (with cable grommet directed down) to the inner cover segment close to the engine. The shutter engine inverter is placed in big „Shutter Control Box” together with the rotary part of the card and the shutter emergency open/close buttons.

After fixing all the devices you have to connect them according the electric scheme. The wires should be routed inside the ribbed laths on the side panel. If you ordered Plug And play wiring you only have to connect all the plugs according to their numbers, eq 1 with 1 or 23 with 23. Very important is to correctly connect the powering lines in the base ring and rotary ring electric connection boxes.

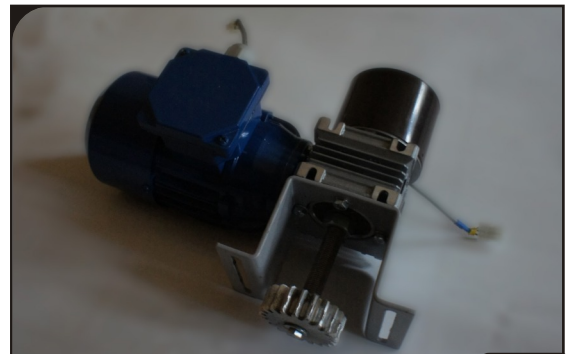

Rotation drive module with the encoder box

Fig. 18

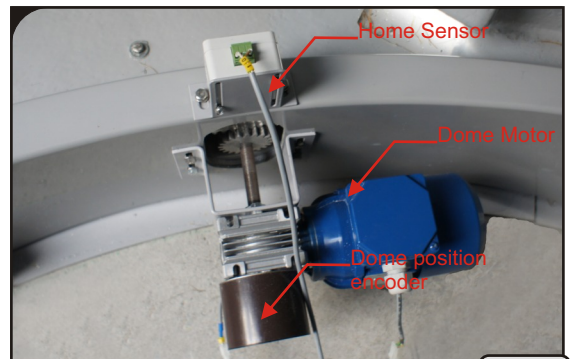

Rotation drive module mounted on the base ring

Fig. 19

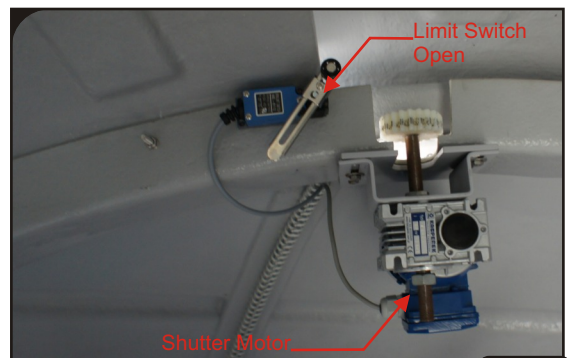

Limit switch OPEN

Fig. 20

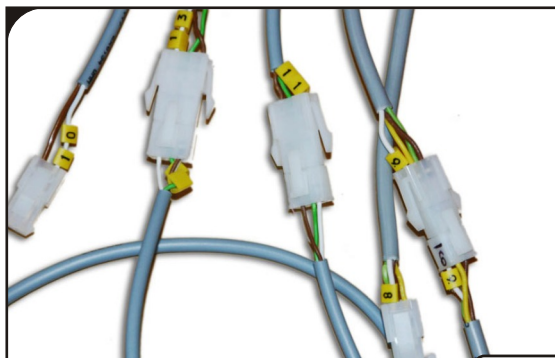

Plug And Play wires with numbered markings

Fig. 23

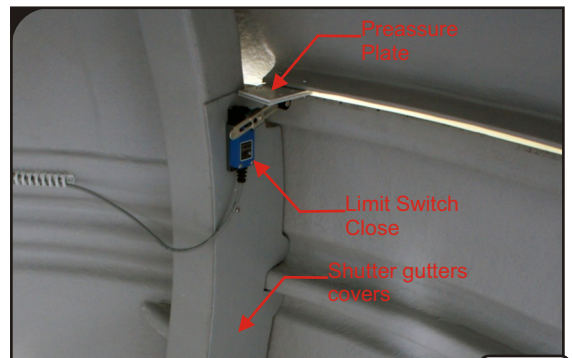

Limit switch CLOSE

Fig. 21



Electric connection box on the rotary part of the dome.
USB card rotary part inside the weather proof box

Fig. 24

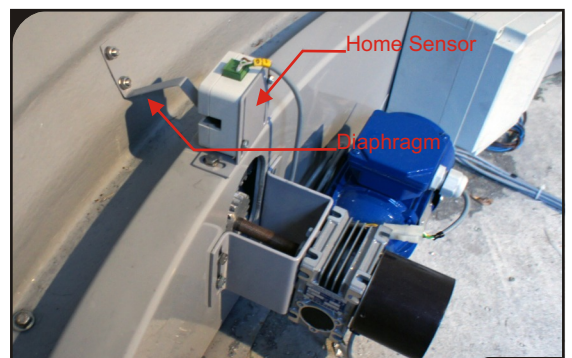

Home Sensor and its diaphragm

Fig. 22

Maintenance and service of the dome

The dome mechanisms should be greased regularly, especially the shutter rear rolls those are exposed to the weather. During the first month of normal functionality the dome will be adapting. For this reason, there is an emergence of a large amount of metal filings. After about 100 revolutions remove the inner covers and clean it up.

Every half year, check that all bolts are tight. In particular, check the engine mounting and driving axes positioning bolts.

If the dome is dirty, wash it with water with any detergent.
Larger stains can be washed with acetone.

